

## Power Metal Film Leaded Resistors



### FEATURES

- High power in small packages (1 W / 0207 size to 3 W / 0617 size)
- Defined fusing characteristics
- Technology: metal film
- Meets active and passive flammability requirements as defined in IEC 60115-1
- AEC-Q200 qualified (PR01 and PR02)
- Material categorization: for definitions of compliance please see [www.vishay.com/doc?99912](http://www.vishay.com/doc?99912)



### DESIGN SUPPORT TOOLS

[click logo to get started](#)

### DESCRIPTION

A homogeneous film of metal alloy is deposited on a high grade ceramic body. After a helical groove has been cut in the resistive layer, tinned connecting wires of electrolytic copper or copper-clad iron are welded to the end-caps. The resistors are coated with a red, non-flammable lacquer which provides electrical, mechanical and climatic protection. This coating is not resistant to aggressive fluxes and cleaning solvents. The encapsulation is resistant to all cleaning solvents in accordance with IEC 60068-2-45.

### APPLICATIONS

- All general purpose power applications
- Automotive electronics
- Lighting ballast

TECHNICAL SPECIFICATIONS					
DESCRIPTION	PR01	PR02 Cu-lead	PR02 FeCu-lead	PR03 Cu-lead	PR03 FeCu-lead
DIN size	0207	0411	0411	0617	0617
Resistance range <sup>(1)</sup>	0.22 Ω to 1 MΩ	0.33 Ω to 1 MΩ	1 Ω to 1 MΩ	0.68 Ω to 1 MΩ	1 Ω to 1 MΩ
Resistance tolerance <sup>(2)</sup>	± 1 %; ± 5 %	± 1 %; ± 5 %	± 1 %; ± 5 %	± 1 %; ± 5 %	± 1 %; ± 5 %
Temperature coefficient	± 250 ppm/K	± 250 ppm/K	± 250 ppm/K	± 250 ppm/K	± 250 ppm/K
Rated dissipation, $P_{70}$					
$1 \Omega \leq R$	1 W	2 W	1.3 W	3 W	2.5 W
$R < 1 \Omega$	0.6 W	1.2 W	-	1.6 W	-
Thermal resistance ( $R_{th}$ )	135 K/W	75 K/W	115 K/W	60 K/W	75 K/W
Operating voltage, $U_{max}$ . AC/DC	350 V	500 V	500 V	750 V	750 V
E-series	E24, E96 (± 1 %); E24 (± 5 %)				
Basic specification	IEC 60115-1				
Stability after:					
Endurance test (1000 h, $P_{70}$ )	$\Delta R$ max.: ± (5 % $R$ + 0.1 Ω)				
Damp heat test (56 days)	$\Delta R$ max.: ± (3 % $R$ + 0.1 Ω)				
Soldering (10 s, 260 °C)	$\Delta R$ max.: ± (1 % $R$ + 0.05 Ω)				

### Notes

<sup>(1)</sup>  $R$  value is measured with probe distance of 24 mm ± 1 mm using 4-terminal method

<sup>(2)</sup> 1 % tolerance is available for  $R_n$ -range from 1 Ω upwards



TERMINATION WIRE TYPES					
PRODUCT TYPE	PACKAGING CODE	STYLE	MATERIAL	WIRE DIAMETER	PITCH
PR01	A1, A5, R5	Axial	Cu	0.58 mm	n/a
	N4	Radial	Cu	0.58 mm	4.8 mm
	L1	Radial	Cu	0.58 mm	17.8 mm
	L1	Radial	FeCu	0.58 mm	17.8 mm
	K1	Radial	FeCu	0.58 mm	12.5 mm
PR02	A1, R5	Axial	Cu	0.78 mm	n/a
	A1	Axial	FeCu	0.58 mm	n/a
	N3, R2	Radial	Cu	0.78 mm	4.8 mm
	L1	Radial	Cu	0.78 mm	17.8 mm
	L1	Radial	FeCu	0.58 mm	17.8 mm
	B1	Radial	FeCu	0.78 mm	15 mm
PR03	AC	Axial	Cu	0.78 mm	n/a
	AC	Axial	FeCu	0.58 mm	n/a
	DC	Radial	Cu	0.78 mm	25.4 mm
	DC	Radial	FeCu	0.58 mm	25.4 mm
	PC	Radial	FeCu	0.78 mm	20 mm

APPLICATION INFORMATION

The power dissipation on the resistor generates a temperature rise against the local ambient, depending on the heat flow support of the printed-circuit board (thermal resistance). The rated dissipation applies only if the permitted film temperature is not exceeded. Furthermore, a high level of ambient temperature or of power dissipation may raise the temperature of the solder joint, hence special solder alloys or board materials may be required to maintain the reliability of the assembly.

These resistors do not feature a limited lifetime when operated within the permissible limits. However, resistance value drift increasing over operating time may result in exceeding a limit acceptable to the specific application, thereby establishing a functional lifetime. The designer may estimate the performance of the particular resistor application or set certain load and temperature limits in order to maintain a desired stability.

OPERATION MODE		POWER
		$P_{70}$
Rated dissipation	PR01	1 W
	PR02	2 W
	PR03	3 W
Applied maximum film temperature, $\vartheta_{F \max.}$		250 °C
Max. resistance change at rated dissipation for resistance range:	PR01	0.22 $\Omega$ to 1 M $\Omega$
	PR02	0.33 $\Omega$ to 1 M $\Omega$
	PR03	0.68 $\Omega$ to 1 M $\Omega$
$ \Delta R/R _{\max.}$ (at $P_{70}$ ) after:	1000 h	5.0 % R + 0.1 $\Omega$



PART NUMBER AND PRODUCT DESCRIPTION																	
Part Number: PR02000201001JA100																	
P	R	0	2	0	0	0	2	0	1	0	0	1	J	A	1	0	0
TYPE/SIZE PR0100 PR0200 PR0300	VARIANT 0 = neutral Z = value overflow (special)	WIRE TYPES 1 = Cu 0.58 (PR01) 2 = Cu 0.78 (PR02, PR03) 3 = FeCu 0.58 (PR01, PR02, PR03) 4 = FeCu 0.78 (PR02, PR03)		TCR/MATERIAL 0 = standard		RESISTANCE 3 digit value 1 digit multiplier Multiplier 7 = *10 <sup>-3</sup> 8 = *10 <sup>-2</sup> 9 = *10 <sup>-1</sup> 0 = *10 <sup>0</sup> 1 = *10 <sup>1</sup> 2 = *10 <sup>2</sup> 3 = *10 <sup>3</sup> 4 = *10 <sup>4</sup>		TOLERANCE F = ± 1 % J = ± 5 %		PACKAGING N4 R2 N3 L1 A5 DC A1 K1 AC B1 R5 PC		SPECIAL 00 = standard					
Product Description: PR02 5 % A1 1K0																	
PR02		5 %		A1		1K0											
TYPE PR01 PR02 PR03		TOLERANCE 1 % 5 %		PACKAGING N4 R2 N3 L1 A5 DC A1 K1 AC B1 R5 PC		RESISTANCE VALUE 1K0 = 1 kΩ 4K75 = 4.75 kΩ											

**Note**

- The products can be ordered using either the PRODUCT DESCRIPTION or the PART NUMBER

PACKAGING						
PRODUCT TYPE	CODE	QUANTITY	DESCRIPTION	PITCH	TAPE WIDTH	DIMENSION
PR01	A5	5000	Ammo pack acc. to IEC 60286-1	5 mm	52 mm	75 mm x 114 mm x 260 mm
	A1	1000	Ammo pack acc. to IEC 60286-1	5 mm	52 mm	78 mm x 31 mm x 260 mm
	N4	4000	Ammo pack acc. to IEC 60286-2	-	-	45 mm x 262 mm x 330 mm
	L1	1000	Loose in bulk	-	-	105 mm x 70 mm x 205 mm
	K1	1000	Loose in bulk	-	-	105 mm x 70 mm x 205 mm
	R5	5000	Reel pack acc. to IEC 60286-1	5 mm	52 mm	93 mm x 300 mm x 298 mm
PR02	A1	1000	Ammo pack acc. to IEC 60286-1	5 mm	52 mm	72 mm x 60 mm x 258 mm
	N3	3000	Ammo pack acc. to IEC 60286-2	-	-	45 mm x 262 mm x 330 mm
	L1	1000	Loose in bulk	-	-	105 mm x 70 mm x 205 mm
	B1	1000	Loose in bulk	-	-	105 mm x 70 mm x 205 mm
	R5	5000	Reel pack acc. to IEC 60286-1	5 mm	52 mm	100 mm x 375 mm x 375 mm
	R2	2000	Reel pack acc. to IEC 60286-2	-	-	90 mm x 375 mm x 375 mm
PR03	AC	500	Ammo pack acc. to IEC 60286-1	10 mm	63 mm	83 mm x 58 mm x 256 mm
	DC	500	Loose in bulk	-	-	105 mm x 70 mm x 205 mm
	PC	500	Loose in bulk	-	-	105 mm x 70 mm x 205 mm



## DESCRIPTION

Production is strictly controlled and follows an extensive set of instructions established for reproducibility. A homogeneous film of metal alloy is deposited on a high grade ceramic body and conditioned to achieve the desired temperature coefficient. Plated steel termination caps are firmly pressed on the metalized rods. Mostly, a special laser is used to achieve the target value by smoothly cutting a helical groove in the resistive layer without damaging the ceramics. Connecting wires of electrolytic copper plated with 100 % pure tin are welded to the termination caps. The resistor elements are covered by a red, non-flammable lacquer protective coating designed for electrical, mechanical, and climatic protection. Four or five color code rings designate the resistance value and tolerance in accordance with **IEC 60062**.

The result of the determined production is verified by an extensive testing procedure performed on 100 % of the individual resistors. Only accepted products are stuck directly on the adhesive tapes in accordance with **IEC 60286-1** or for the radial versions in accordance to **IEC 60286-2**.

## MATERIALS

Vishay acknowledges the following systems for the regulation of hazardous substances:

- IEC 62474, Material Declaration for Products of and for the Electrotechnical Industry, with the list of declarable substances given therein <sup>(1)</sup>
- The Global Automotive Declarable Substance List (GADSL) <sup>(2)</sup>
- The REACH regulation (1907/2006/EC) and the related list of substances with very high concern (SVHC) <sup>(3)</sup> for its supply chain

The products do not contain any of the banned substances as per IEC 62474, GADSL, or the SVHC list, see [www.vishay.com/how/leadfree](http://www.vishay.com/how/leadfree).

Hence the products fully comply with the following directives:

- 2000/53/EC End-of-Life Vehicle Directive (ELV) and Annex II (ELV II)
- 2011/65/EU Restriction of the Use of Hazardous Substances Directive (RoHS) with amendment 2015/863/EU
- 2012/19/EU Waste Electrical and Electronic Equipment Directive (WEEE)

Vishay pursues the elimination of conflict minerals from its supply chain, see the Conflict Minerals Policy at [www.vishay.com/doc?49037](http://www.vishay.com/doc?49037).

## Notes

<sup>(1)</sup> The IEC 62474 list of declarable substances is maintained in a dedicated database, which is available at <http://std.iec.ch/iec62474>

<sup>(2)</sup> The Global Automotive Declarable Substance List (GADSL) is maintained by the American Chemistry Council, and available at [www.gadsl.org](http://www.gadsl.org)

<sup>(3)</sup> The SVHC list is maintained by the European Chemical Agency (ECHA) and available at <http://echa.europa.eu/candidate-list-table>

## ASSEMBLY

The resistors are suitable for processing on automatic insertion equipment and cutting and bending machines. Excellent solderability is proven, even after extended storage. They are suitable for automatic soldering using wave or dipping.

The resistors are completely lead (Pb)-free, the pure tin plating provides compatibility with lead (Pb)-free and lead-containing soldering processes. The immunity of the plating against tin whisker growth, in compliance with IEC 60068-2-82, has been proven under extensive testing.

The encapsulant is resistant to cleaning solvent specified in IEC 60115-1. The suitability of conformal coatings, if applied, shall be qualified by appropriate means to ensure the long-term stability of the whole system.

## RELATED PRODUCTS

For a correlated range of Metal Film Resistors see the datasheet:

“High Ohmic / High Voltage Metal Film Leaded Resistors”, [www.vishay.com/doc?30260](http://www.vishay.com/doc?30260)

For product that offers high power dissipation and metal oxide film technology see the datasheet:

“High Power Metal Oxide Leaded Resistors”, [www.vishay.com/doc?20128](http://www.vishay.com/doc?20128)

**FUNCTIONAL PERFORMANCE**

The power that the resistor can dissipate depends on the operating temperature.



**Derating**

Maximum dissipation ( $P_{max.}$ ) in percentage of rated power as a function of the ambient temperature ( $T_{amb}$ )



Ø 0.58 mm Cu-leads

Minimum distance from resistor body to PCB = 1 mm

**PR01** Temperature rise ( $\Delta T$ ) at the lead end (soldering point) as a function of dissipated power at various lead lengths after mounting.



Ø 0.58 mm FeCu-leads

Minimum distance from resistor body to PCB = 1 mm

**PR01** Temperature rise ( $\Delta T$ ) at the lead end (soldering point) as a function of dissipated power at various lead lengths after mounting.



Ø 0.58 mm FeCu-leads

Minimum distance from resistor body to PCB = 1 mm

**PR02** Temperature rise ( $\Delta T$ ) at the lead end (soldering point) as a function of dissipated power at various lead lengths after mounting.



Ø 0.78 mm Cu-leads

Minimum distance from resistor body to PCB = 1 mm

**PR02** Temperature rise ( $\Delta T$ ) at the lead end (soldering point) as a function of dissipated power at various lead lengths after mounting.



Ø 0.78 mm FeCu-leads  
 Minimum distance from resistor body to PCB = 1 mm  
**PR02** Temperature rise ( $\Delta T$ ) at the lead end (soldering point) as a function of dissipated power at various lead lengths after mounting.



Ø 0.78 mm Cu-leads  
 Minimum distance from resistor body to PCB = 1 mm  
**PR03** Temperature rise ( $\Delta T$ ) at the lead end (soldering point) as a function of dissipated power at various lead lengths after mounting.



Ø 0.58 mm FeCu-leads  
 Minimum distance from resistor body to PCB = 1 mm  
**PR03** Temperature rise ( $\Delta T$ ) at the lead end (soldering point) as a function of dissipated power at various lead lengths after mounting.



Ø 0.78 mm FeCu-leads  
 Minimum distance from resistor body to PCB = 1 mm  
**PR03** Temperature rise ( $\Delta T$ ) at the lead end (soldering point) as a function of dissipated power at various lead lengths after mounting.



Ø 0.58 mm Cu-leads

PR01 Hot-spot temperature rise ( $\Delta T$ ) as a function of dissipated power.



Ø 0.58 mm FeCu-leads

PR01 Hot-spot temperature rise ( $\Delta T$ ) as a function of dissipated power.



Ø 0.78 mm Cu-leads

PR02 Hot-spot temperature rise ( $\Delta T$ ) as a function of dissipated power.



Ø 0.78 mm FeCu-leads

PR02 Hot-spot temperature rise ( $\Delta T$ ) as a function of dissipated power.



Ø 0.58 mm FeCu-leads

PR02 Hot-spot temperature rise ( $\Delta T$ ) as a function of dissipated power.



Ø 0.58 mm FeCu-leads

PR03 Hot-spot temperature rise ( $\Delta T$ ) as a function of dissipated power.



Ø 0.78 mm Cu-leads

PR03 Hot-spot temperature rise ( $\Delta T$ ) as a function of dissipated power.



Ø 0.78 mm FeCu-leads

PR03 Hot-spot temperature rise ( $\Delta T$ ) as a function of dissipated power.





The maximum permissible hot-spot temperature is 205 °C for PR01, 220 °C for PR02 and 250 °C for PR03.



PR01 Drift nomogram



PR02 Drift nomogram



PR03 Drift nomogram



PR01 Pulse on a regular basis; maximum permissible peak pulse power ( $\hat{P}_{max}$ ) as a function of pulse duration ( $t_i$ )



PR01 Pulse on a regular basis; maximum permissible peak pulse voltage ( $\hat{U}_{max}$ ) as a function of pulse duration ( $t_i$ )



PR02 Pulse on a regular basis; maximum permissible peak pulse power ( $\hat{P}_{max}$ ) as a function of pulse duration ( $t_i$ )



PR02 Pulse on a regular basis; maximum permissible peak pulse voltage ( $\hat{U}_{max}$ ) as a function of pulse duration ( $t_i$ )



PR03 Pulse on a regular basis; maximum permissible peak pulse power ( $\hat{P}_{max}$ ) as a function of pulse duration ( $t_i$ )



PR03 Pulse on a regular basis; maximum permissible peak pulse voltage ( $\hat{U}_{max}$ ) as a function of pulse duration ( $t_i$ )



**PR01** Time to interruption as a function of overload power for range:  $0.22 \Omega \leq R_n < 1 \Omega$   
 This graph is based on measured data under constant voltage conditions; the data may deviate according to the applications.

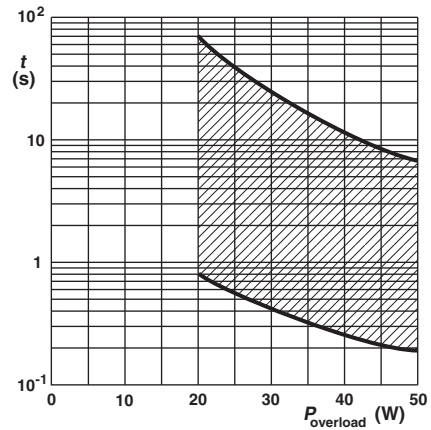

**PR01** Time to interruption as a function of overload power for range:  $16 \Omega \leq R_n \leq 560 \Omega$   
 This graph is based on measured data under constant voltage conditions; the data may deviate according to the applications.

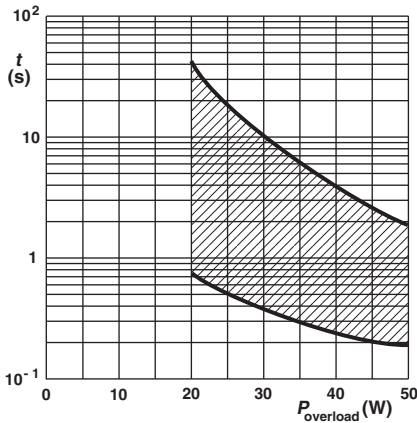

**PR01** Time to interruption as a function of overload power for range:  $1 \Omega \leq R_n \leq 15 \Omega$   
 This graph is based on measured data under constant voltage conditions; the data may deviate according to the applications.

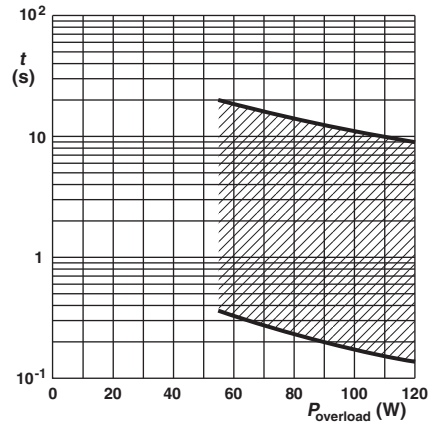

**PR02** Time to interruption as a function of overload power for range:  $0.33 \Omega \leq R_n \leq 5 \Omega$   
 This graph is based on measured data under constant voltage conditions; the data may deviate according to the applications.



**PR02** Time to interruption as a function of overload power for range:  $5 \Omega \leq R_n \leq 68 \Omega$   
 This graph is based on measured data under constant voltage conditions; the data may deviate according to the applications.

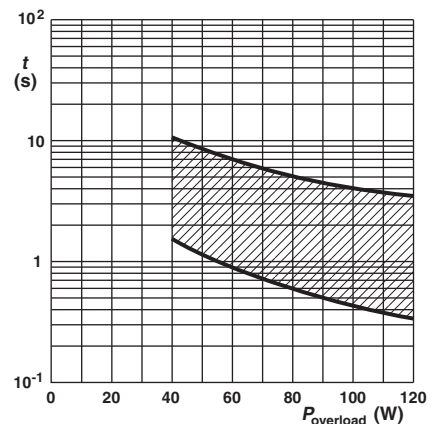

**PR02** Time to interruption as a function of overload power for range:  $68 \Omega \leq R_n \leq 560 \Omega$   
 This graph is based on measured data under constant voltage conditions; the data may deviate according to the applications.



**PR03** Time to interruption as a function of overload power for range:  $0.68 \Omega \leq R_n \leq 560 \Omega$

This graph is based on measured data under constant voltage conditions; the data may deviate according to the applications.

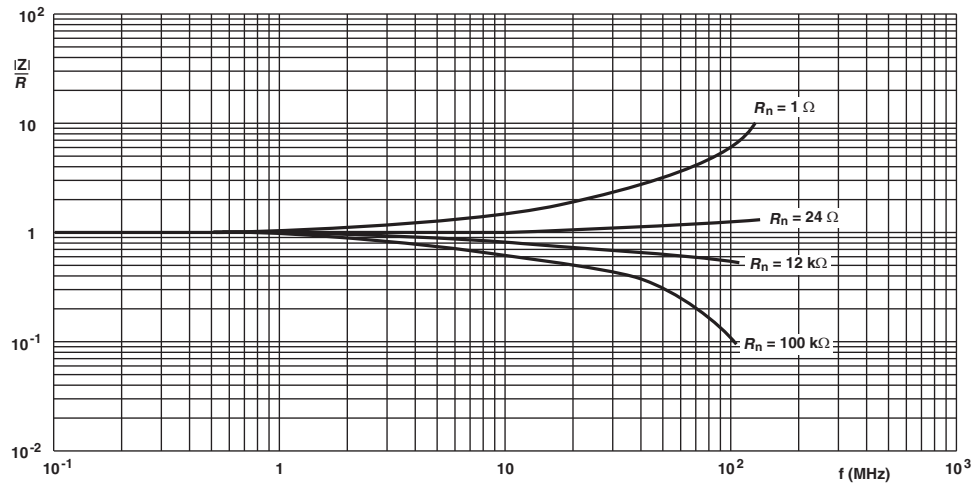

PR01 Impedance as a function of applied frequency

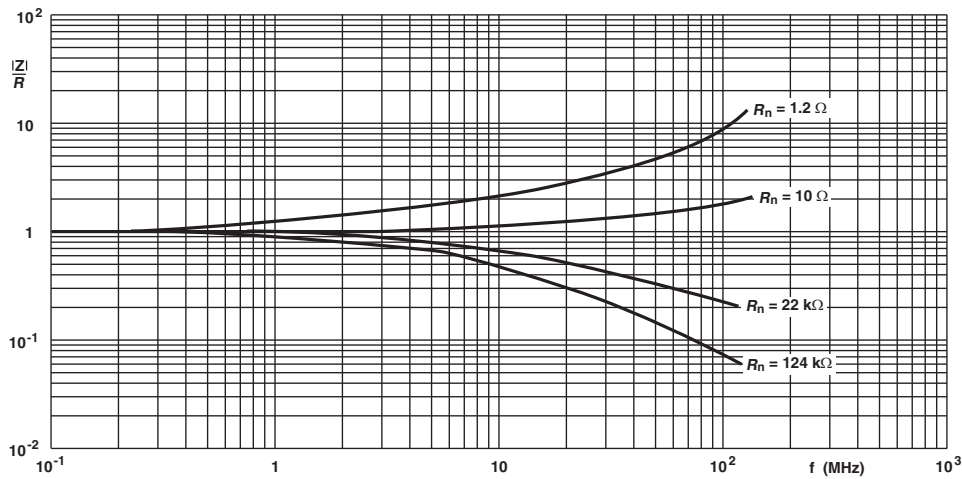

PR02 Impedance as a function of applied frequency

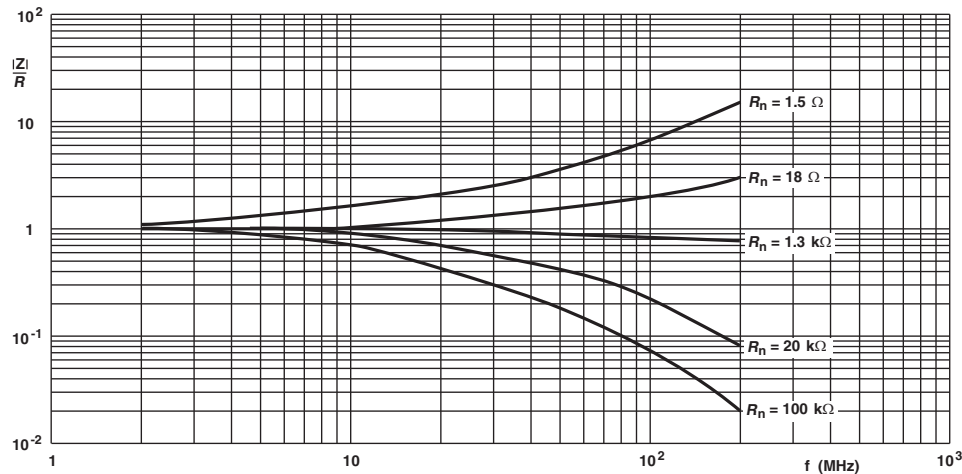

PR03 Impedance as a function of applied frequency



**TESTS PROCEDURES AND REQUIREMENTS**

All tests are carried out in accordance with the following specifications:

- IEC 60115-1, generic specification (includes tests)

The test and requirements table contains only the most important tests. For the full test schedule refer to the documents listed above.

The tests are carried out in accordance with IEC 60068-2-xx test method and under standard atmospheric conditions in accordance with IEC 60068-1, 5.3.

Climatic category LCT / UCT / 56 (rated temperature range: lower category temperature, upper category temperature; damp heat, steady state, test duration: 56 days) is valid.

Unless otherwise specified the following values apply:

- Temperature: 15 °C to 35 °C
- Relative humidity: 45 % to 75 %
- Air pressure: 86 kPa to 106 kPa (860 mbar to 1060 mbar).

For performing some of the tests, the components are mounted on a test board in accordance with IEC 60115-1, 4.31.

In test procedures and requirements table, only the tests and requirements are listed with reference to the relevant clauses of IEC 60115-1 and IEC 60068-2-xx test methods. A short description of the test procedure is also given.

TEST PROCEDURES AND REQUIREMENTS				
IEC 60115-1 CLAUSE	IEC 60068-2-TEST METHOD	TEST	PROCEDURE	REQUIREMENTS PERMISSIBLE CHANGE ( $\Delta R_{max.}$ )
4.4.1	-	Visual examination		No holes; clean surface; no damage
4.4.2	-	Dimensions (outline)	Gauge (mm)	See Straight and Kinked Dimensions tables
4.5	-	Resistance		$\pm 5 \% R$
4.6.1.1	-	Insulation resistance	Maximum voltage (DC) after 1 min; metal block method	$R_{ins \text{ min.}}: 10^4 \text{ M}\Omega$
4.7	-	Voltage proof	$U_{RMS} = U_{ins}; 60 \text{ s}$	No breakdown or flashover
4.8	-	Temperature coefficient	At (20 / -55 / 20) °C and (20 / 155 / 20) °C	$\leq \pm 250 \text{ ppm/K}$
4.16	21 (Ja) 21 (Ub) 21 (Uc)	Robustness of terminations	Tensile, bending, and torsion	No damage $\Delta R_{max.}: \pm (0.5 \% R + 0.05 \Omega)$
4.17	20 (Ta)	Solderability	+235 °C; 2 s; solder bath method; SnPb40	Good tinning ( $\geq 95 \%$ covered, no visible damage)
			+245 °C; 3 s; solder bath method; SnAg3Cu0.5	Good tinning ( $\geq 95 \%$ covered, no visible damage)
4.18.2	20 (Tb)	Resistance to soldering heat	Unmounted components (260 $\pm$ 5) °C; (10 $\pm$ 1) s	$\Delta R_{max.}: \pm (1 \% R + 0.05 \Omega)$
4.19	14 (Na)	Rapid change of temperature	30 min at -55 °C and 30 min at +200 °C; 5 cycles	No visual damage <b>PR01:</b> $\Delta R_{max.}: \pm (1 \% R + 0.05 \Omega)$ <b>PR02:</b> $\Delta R_{max.}: \pm (1 \% R + 0.05 \Omega)$ <b>PR03:</b> $\Delta R_{max.}: \pm (2 \% R + 0.05 \Omega)$
4.20	29 (Eb)	Bump	3 x 1500 bumps in three directions; 40 g	No damage $\Delta R_{max.}: \pm (0.5 \% R + 0.05 \Omega)$
4.22	6 (Fc)	Vibration	10 sweep cycles per direction; 10 Hz to 2000 Hz; 1.5 mm or 200 m/s <sup>2</sup>	No damage $\Delta R_{max.}: \pm (0.5 \% R + 0.05 \Omega)$



TEST PROCEDURES AND REQUIREMENTS				
IEC 60115-1 CLAUSE	IEC 60068-2-TEST METHOD	TEST	PROCEDURE	REQUIREMENTS PERMISSIBLE CHANGE ( $\Delta R_{max.}$ )
4.23		Climatic sequence:		
4.23.2	2 (Ba)	Dry heat	200 °C; 16 h	$R_{ins \text{ min.}}: 10^3 \text{ M}\Omega$ $\Delta R_{max.}: \pm (1.5 \% R + 0.1 \Omega)$
4.23.3	30 (Db)	Damp heat, cyclic	55 °C; 24 h; 90 % to 100 % RH; 1 cycle	
4.23.4	1 (Aa)	Cold	-55 °C; 2 h	
4.23.5	13 (M)	Low air pressure	8.5 kPa; 2 h; 15 °C to 35 °C	
4.23.6	30 (Db)	Damp heat, cyclic	55 °C; 5 days; 95 % to 100 % RH; 5 cycles	
4.24	78 (Cab)	Damp heat (steady state)	(40 ± 2) °C; 56 days; (93 ± 3) % RH	
4.25.1	-	Endurance (at 70 °C)	$U = \sqrt{P_{70}} \times \bar{R}$ or $U = U_{max.}$ ; 1.5 h on; 0.5 h off; 70 °C; 1000 h	$\Delta R_{max.}: \pm (5 \% R + 0.1 \Omega)$
4.26	-	Active flammability	Accidental overload test	No damage, no flaming of gauze cylinder
4.29	45 (Xa)	Component solvent resistance	Isopropyl alcohol (used in industrial application) +23 °C; toothbrush method	Marking legible; no visible damage
4.35	-	Passive flammability	Needle flame test	No ignition of product, no ignition of under layer burning time is less than 30 s



**DIMENSIONS**

Type with straight leads

<b>DIMENSIONS</b> - Straight lead type and relevant physical dimensions; see straight leads outline						
TYPE	Ø D <sub>MAX.</sub> (mm)	L <sub>1</sub> MAX. (mm)	L <sub>2</sub> MAX. (mm)	TERMINATION WIRE MATERIAL (Cu OR FeCu) AND WIRE DIAMETER (Ø d)		MASS (mg)
				MATERIAL	Ø d (mm)	
PR01	2.5	6.5	8.0	Cu	0.58 ± 0.05	212
				FeCu	0.58 ± 0.05	207
PR02	3.9	10.0	12.0	Cu	0.78 ± 0.05	504
				FeCu	0.58 ± 0.05	455
				FeCu	0.78 ± 0.05	496
PR03	5.2	16.7	19.5	Cu	0.78 ± 0.05	1192
				FeCu	0.58 ± 0.05	1079
				FeCu	0.78 ± 0.05	1185

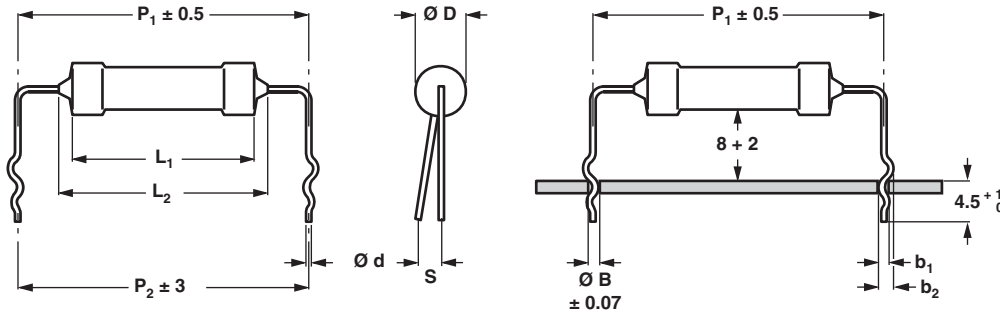

Type with double kink

Dimensions in millimeters

<b>DIMENSIONS</b> - Double kink lead type and relevant physical dimensions; see double kinked outline													
TYPE	Ø D <sub>MAX.</sub> (mm)	L <sub>1</sub> MAX. (mm)	L <sub>2</sub> MAX. (mm)	TERMINATION WIRE MATERIAL (Cu OR FeCu) AND WIRE DIAMETER (Ø d)		MASS (mg)	PITCH (mm)	P <sub>1</sub> (mm)	P <sub>2</sub> (mm)	b <sub>1</sub> (mm)	b <sub>2</sub> (mm)	S <sub>MAX.</sub> (mm)	Ø B (mm)
				MATERIAL	Ø d (mm)								
PR01	2.5	6.5	8.0	Cu	0.58 ± 0.05	212	17.8	17.8 ± 0.5	17.8 ± 3	1.10 + 0.25 / - 0.20	1.45 + 0.25 / - 0.20	2	0.8 ± 0.07
				FeCu	0.58 ± 0.05	207	12.5	12.5 ± 0.5	12.5 ± 3	1.10 + 0.25 / - 0.20	1.45 + 0.25 / - 0.20	2	0.8 ± 0.07
				FeCu	0.58 ± 0.05	207	17.8	17.8 ± 0.5	17.8 ± 3	1.10 + 0.25 / - 0.20	1.45 + 0.25 / - 0.20	2	0.8 ± 0.07
PR02	3.9	10.0	12.0	Cu	0.78 ± 0.05	504	17.8	17.8 ± 0.5	17.8 ± 3	1.10 + 0.25 / - 0.20	1.45 + 0.25 / - 0.20	2	1.0 ± 0.07
				FeCu	0.58 ± 0.05	455	17.8	17.8 ± 0.5	17.8 ± 3	1.10 + 0.25 / - 0.20	1.45 + 0.25 / - 0.20	2	0.8 ± 0.07
				FeCu	0.78 ± 0.05	496	15.0	15.0 ± 0.5	15.0 ± 3	1.30 + 0.25 / - 0.20	1.65 + 0.25 / - 0.20	2	1.0 ± 0.07
PR03	5.2	16.7	19.5	Cu	0.78 ± 0.05	1192	25.4	25.4 ± 0.5	25.4 ± 3	1.10 + 0.25 / - 0.20	1.65 + 0.25 / - 0.20	2	1.0 ± 0.07
				FeCu	0.58 ± 0.05	1079	25.4	25.4 ± 0.5	25.4 ± 3	1.10 + 0.25 / - 0.20	1.65 + 0.25 / - 0.20	2	1.0 ± 0.07
				FeCu	0.78 ± 0.05	1185	20	22.0 ± 0.5	20.0 ± 3	1.30 + 0.25 / - 0.20	2.15 + 0.25 / - 0.20	2	1.0 ± 0.07

**PR01, PR02 WITH RADIAL TAPING**
**PR01 - Height for insertion (max.) = 32 mm**

DIMENSIONS in millimeters		
Pitch of components	P	12.7 ± 1.0
Feed-hole pitch	P <sub>0</sub>	12.7 ± 0.2
Feed-hole centre to lead at topside at the tape	P <sub>1</sub>	3.85 ± 0.5
Feed-hole center to body center	P <sub>2</sub>	6.35 ± 1.0
Lead spacing	F	4.8 +0.7/-0
Width of carrier tape	W	18.0 ± 0.5
Minimum hold down tape width	W <sub>0</sub>	5.5
Height for insertion (max.)	H <sub>1</sub>	32
Lead wire clinch height	H <sub>0</sub>	16.5 ± 0.5
Body to hole center	H	19.5 ± 1
Feed-hole diameter	D <sub>0</sub>	4.0 ± 0.2
Height for cutting (max.)	L	11.0
Minimum lead wire (tape portion) shortest lead	L <sub>1</sub>	2.5

**PR02 - Height for insertion (max.) = 29 mm**

DIMENSIONS in millimeters		
Pitch of components	P	12.7 ± 1.0
Feed-hole pitch	P <sub>0</sub>	12.7 ± 0.2
Feed-hole centre to lead at topside at the tape	P <sub>1</sub>	3.85 ± 0.5
Feed-hole center to body center	P <sub>2</sub>	6.35 ± 1.0
Lead spacing	F	4.8 +0.7/-0
Width of carrier tape	W	18.0 ± 0.5
Minimum hold down tape width	W <sub>0</sub>	5.5
Height for insertion (max.)	H <sub>1</sub>	29
Lead wire clinch height	H <sub>0</sub>	16.5 ± 0.5
Body to hole center	H	19.5 ± 1
Feed-hole diameter	D <sub>0</sub>	4.0 ± 0.2
Height for cutting (max.)	L	11.0
Minimum lead wire (tape portion) shortest lead	L <sub>1</sub>	2.5

**MARKING**

The nominal resistance and tolerance are marked on the resistor using four or five colored bands in accordance with IEC 60062, marking codes for resistors and capacitors.



**12NC INFORMATION FOR HISTORICAL CODING REFERENCE**

The resistors have a 12-digit numeric code starting with 23

For 5 % tolerance:

- The next 7 digits indicate the resistor type and packing
- The remaining 3 digits indicate the resistance value:
  - The first 2 digits indicate the resistance value
  - The last digit indicates the resistance decade

For 1 % tolerance:

- The next 6 digits indicate the resistor type and packing
- The remaining 4 digits indicate the resistance value:
  - The first 3 digits indicate the resistance value
  - The last digit indicates the resistance decade

**Last Digit of 12NC Indicating Resistance Decade**

RESISTANCE DECADE	LAST DIGIT
0.22 Ω to 0.91 Ω	7
1 Ω to 9.76 Ω	8
10 Ω to 97.6 Ω	9
100 Ω to 976 Ω	1
1 Ω to 9.76 kΩ	2
10 Ω to 97.6 kΩ	3
100 Ω to 976 kΩ	4
1 MΩ	5

**12NC Example**

The 12NC for resistor type PR02 with Cu leads and a value of 750 Ω with 5 % tolerance, supplied on a bandolier of 1000 units in ammopack, is: 2306 198 53751.

<b>12NC - Resistor Type and Packaging <sup>(1)</sup></b>									
TYPE	LEAD Ø mm	TOL. (%)	23.. ... .. (BANDOLIER)						
			AMMOPACK				REEL		
			RADIAL TAPED		STRAIGHT LEADS			RADIAL TAPED	
			4000 UNITS	3000 UNITS	52 mm	52 mm	63 mm		52 mm
5000 UNITS	1000 UNITS	500 UNITS	5000 UNITS	2000 UNITS					
PR01	Cu 0.58	1	-	-	<b>22 196 1...</b>	06 191 2...	-	06 191 5...	-
		5	06 197 03...	-	<b>22 193 14...</b>	06 197 53...	-	<b>06 197 23...</b>	-
PR02	Cu 0.78	1	-	22 197 2...	-	<b>22 197 1...</b>	-	-	<b>2322 197 5...</b>
		5	-	06 198 03...	-	<b>06 198 53...</b>	-	-	<b>2322 198 04...</b>
	FeCu 0.58	5	-	-	-	22 194 54...	-	-	-
PR03	Cu 0.78	5	-	-	-	-	<b>22 195 14...</b>	-	-
		1	-	-	-	-	<b>06 199 6...</b>	-	-
	FeCu 0.58	5	-	-	-	-	<b>22 195 54...</b>	-	-

**Notes**

- Preferred types in bold
- (1) Other packaging versions are available on request

<b>12NC - Resistor Type and Packaging</b>								
TYPE	LEAD Ø mm	TOL. (%)	23.. ... .. (LOOSE IN BOX)					
			DOUBLE KINK					
			PITCH = 17.8 mm		PITCH = 25.4 mm		PITCH <sup>(2)(3)(4)</sup>	
			1000 UNITS		500 UNITS		500 UNITS	
PR01	Cu 0.58	5	22 193 03...	-	-	-		
	FeCu 0.58	5	22 193 43...	-	<b>22 193 53...</b> <sup>(2)</sup>	-		
PR02	Cu 0.78	5	22 194 23...	-	-	-		
	FeCu 0.58	5	22 194 83...	-	-	-		
	FeCu 0.78	5	-	-	<b>22 194 63...</b> <sup>(3)</sup>	-		
PR03	Cu 0.78	5	-	22 195 23...	-	-		
	FeCu 0.58	5	-	22 195 83...	-	-		
	FeCu 0.78	5	-	-	-	<b>22 195 63...</b> <sup>(4)</sup>		

**Notes**

- Preferred types in bold
- (2) PR01 pitch 12.5 mm
- (3) PR02 pitch 15.0 mm
- (4) PR03 pitch 20.0 mm, with reversed kinking direction as opposed to the drawing for the type with double kink figure



## **Disclaimer**

ALL PRODUCT, PRODUCT SPECIFICATIONS AND DATA ARE SUBJECT TO CHANGE WITHOUT NOTICE TO IMPROVE RELIABILITY, FUNCTION OR DESIGN OR OTHERWISE.

Vishay Intertechnology, Inc., its affiliates, agents, and employees, and all persons acting on its or their behalf (collectively, "Vishay"), disclaim any and all liability for any errors, inaccuracies or incompleteness contained in any datasheet or in any other disclosure relating to any product.

Vishay makes no warranty, representation or guarantee regarding the suitability of the products for any particular purpose or the continuing production of any product. To the maximum extent permitted by applicable law, Vishay disclaims (i) any and all liability arising out of the application or use of any product, (ii) any and all liability, including without limitation special, consequential or incidental damages, and (iii) any and all implied warranties, including warranties of fitness for particular purpose, non-infringement and merchantability.

Statements regarding the suitability of products for certain types of applications are based on Vishay's knowledge of typical requirements that are often placed on Vishay products in generic applications. Such statements are not binding statements about the suitability of products for a particular application. It is the customer's responsibility to validate that a particular product with the properties described in the product specification is suitable for use in a particular application. Parameters provided in datasheets and / or specifications may vary in different applications and performance may vary over time. All operating parameters, including typical parameters, must be validated for each customer application by the customer's technical experts. Product specifications do not expand or otherwise modify Vishay's terms and conditions of purchase, including but not limited to the warranty expressed therein.

Except as expressly indicated in writing, Vishay products are not designed for use in medical, life-saving, or life-sustaining applications or for any other application in which the failure of the Vishay product could result in personal injury or death. Customers using or selling Vishay products not expressly indicated for use in such applications do so at their own risk. Please contact authorized Vishay personnel to obtain written terms and conditions regarding products designed for such applications.

No license, express or implied, by estoppel or otherwise, to any intellectual property rights is granted by this document or by any conduct of Vishay. Product names and markings noted herein may be trademarks of their respective owners.